

# MAGELLAN DESIGNS

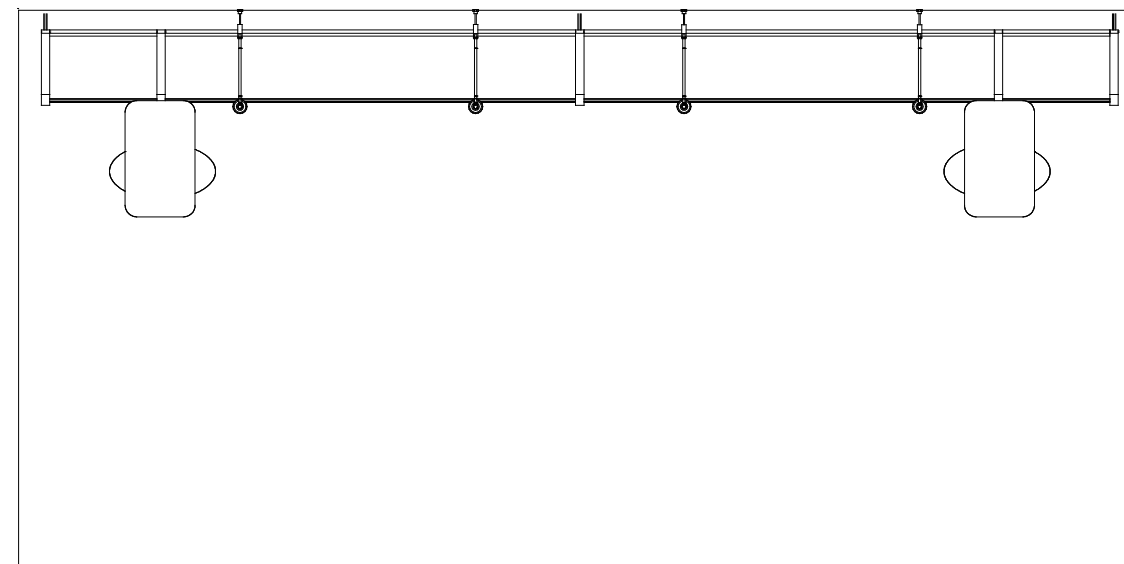
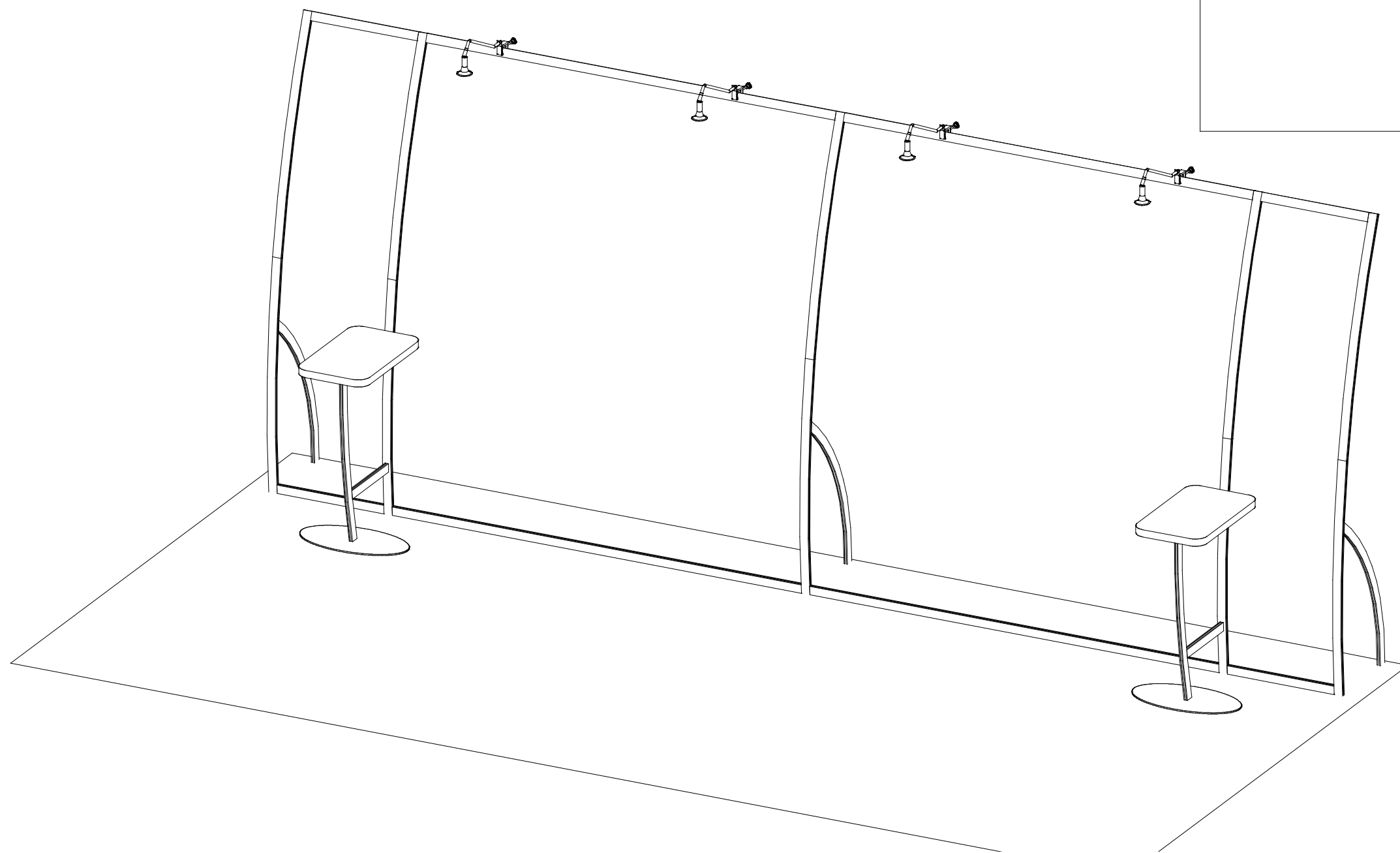

20'

Plan View

10'

WHEN DISASSEMBLING ALUMINUM EXTRUSION, TIGHTEN ALL SETSCREWS AND LOCKS TO PREVENT LOSS DURING SHIPPING

# MAGELLAN DESIGNS

## Using Your Set-up Instructions:

The Visionary Designs Set-up Instructions for Magellan displays are created specifically for your configuration. They are laid out sequentially, including an exploded view of the entire display and a logical series of detailed steps for assembly. We encourage you to study the instructions **before** attempting to assemble your exhibit.

### THIS IS VERY IMPORTANT!

Each page reminds you to tighten the setscrews after disassembling your exhibit to prevent loss of the locks and setscrews (see below in red).

## Cleaning & Packing Your Display:

- 1) Use care when cleaning aluminum extrusions or acrylic inserts. Use only non-abrasive cleaners.
- 2) When cleaning laminate inserts or counter tops, use mild cleansers and a soft material such as cotton.
- 3) Keep all display components away from extreme heat and long exposure to sunlight to avoid warping and fading.
- 4) Retain all packing materials. It will make re-packing much easier and will reduce the likelihood of shipping damage.

Hex Key Tool



Most visionary design exhibits can be assembled with the supplied Hex Key Tool. Occasionally, a flat head screwdriver may be required.

Typical Connection



Detail A: Most horizontal extrusion connections have a patented expandable lock. This lock inserts into the groove of an opposing extrusion. Tightening the lock with the Hex Key Tool expands the lock and creates a strong positive connection.

Typical Connection



Numbered Label

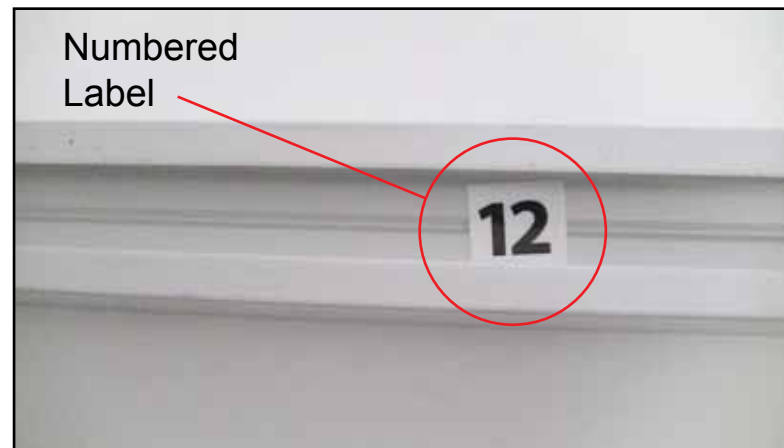

Detail B: Each extrusion contains a numbered label that corresponds to set-up instructions. The label is located within a groove of the extrusion (when possible). Visionary Design labels contain Black numbers unless otherwise specified.

Horizontal Connection

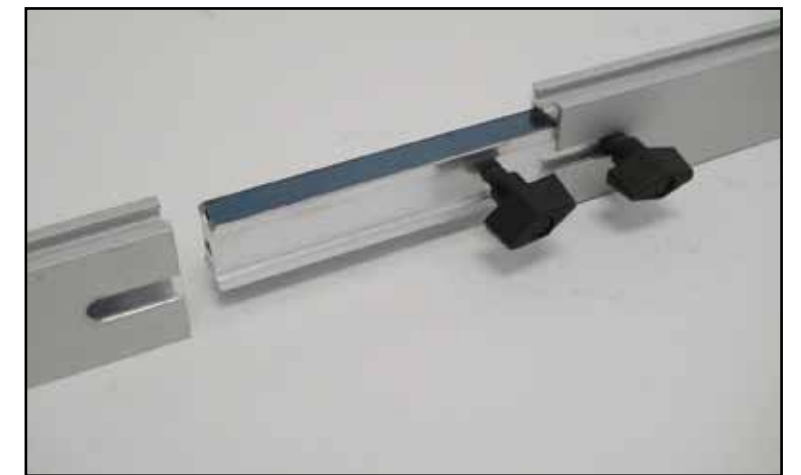

Detail C: A rectangular connection bar with plastic T Knobs is inserted between two horizontal extrusions joined end-to-end. Turn the knobs clockwise to tighten. Do Not Overtighten.

**WHEN DISASSEMBLING ALUMINUM EXTRUSION, TIGHTEN ALL SETSCREWS AND LOCKS TO PREVENT LOSS DURING SHIPPING**

866.652.2100

Part Number	Qty	Description
1	1	48.5" h Lower Curved Extrusion
2	1	48.5" h Upper Curved Extrusion
3	1	48.5" h Lower Curved Extrusion
4	1	48.5" h Upper Curved Extrusion
5	1	48.5" h Lower Curved Extrusion
6	1	48.5" h Upper Curved Extrusion
7	1	23" w Lower Horizontal Extrusion
8	1	23" w Upper Horizontal Extrusion
9a/9b	1/1	44" w Lower Horizontal Extrusion
10a/10b	1/1	44" w Upper Horizontal Extrusion
11	1	Backwall Support Leg Extrusion
12	1	Backwall Support Leg Extrusion

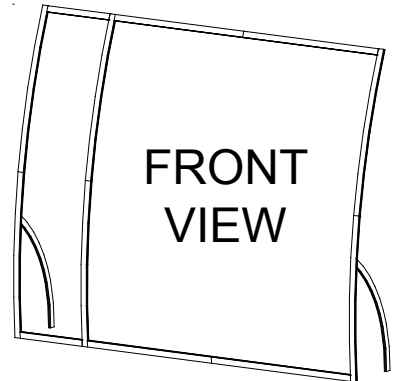
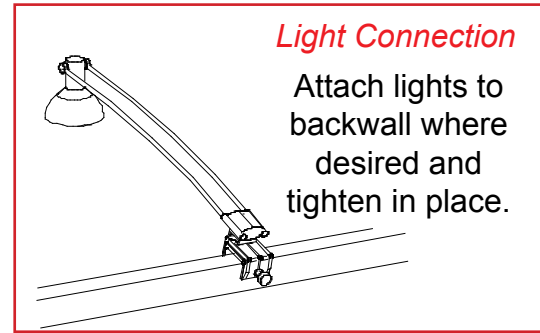

Steps

*Unit can be assembled face down on the floor then lifted upright.*

- 1) Connect upper and lower vertical extrusions together [1 to 2, 3 to 4 and 5 to 6].
- 2) Connect horizontal extrusions together [9a to 9b and 10a to 10b].
- 3) Attach horizontal extrusions [7 and 8] between vertical assemblies [1/2 and 3/4].
- 4) Attach horizontal assemblies [9a/9b and 10a/10b] between vertical assemblies [3/4 and 5/6].
- 5) Attach support leg extrusions [11 and 12] to back of verticals [1 and 5], see leg attachment detail.

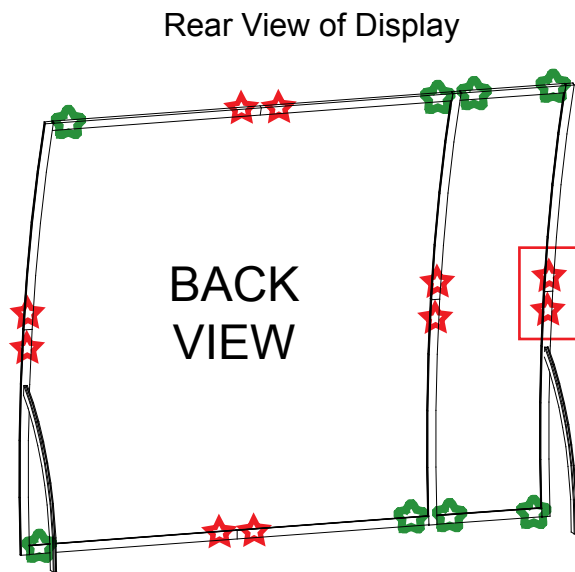

RED STAR indicates location of connection bar knob.

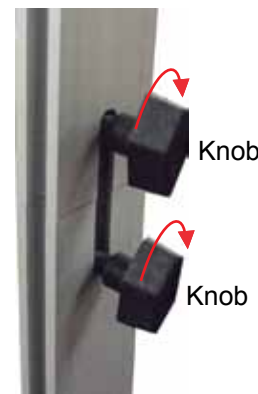

Turn Knob Clockwise to Tighten Lock  
\*\*Do not over tighten Knobs.\*\*

Velcro at left & right of bar

Support Leg Attachment (If accidentally removed from vertical)

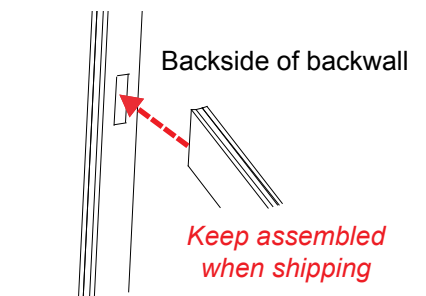

Backside of backwall  
Keep assembled when shipping  
Connect support leg to vertical by placing lock into slot and tighten with Allen Wrench.

BACK VIEW

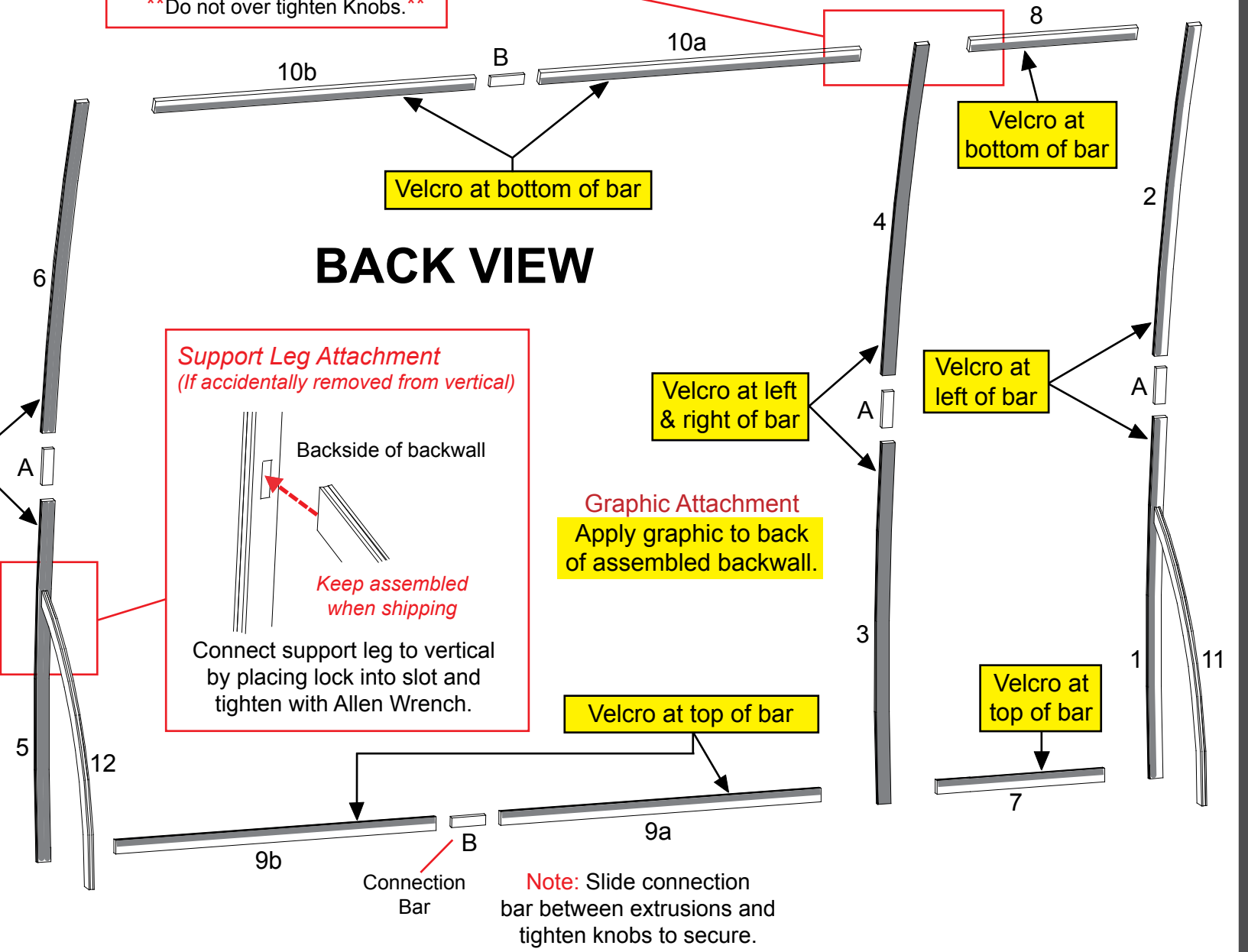

Graphic Attachment Apply graphic to back of assembled backwall.

Note: Slide connection bar between extrusions and tighten knobs to secure.

WHEN DISASSEMBLING ALUMINUM EXTRUSION, TIGHTEN ALL SETSCREWS AND LOCKS TO PREVENT LOSS DURING SHIPPING

Part Number	Qty	Description
13	1	48.5"h Lower Curved Extrusion
14	1	48.5"h Upper Curved Extrusion
15	1	48.5"h Lower Curved Extrusion
16	1	48.5"h Upper Curved Extrusion
17a/17b	1/1	44"w Lower Horizontal Extrusion
18a/18b	1/1	44"w Upper Horizontal Extrusion
19	1	23"w Lower Horizontal Extrusion
20	1	23"w Upper Horizontal Extrusion
21	1	Backwall Support Leg Extrusion

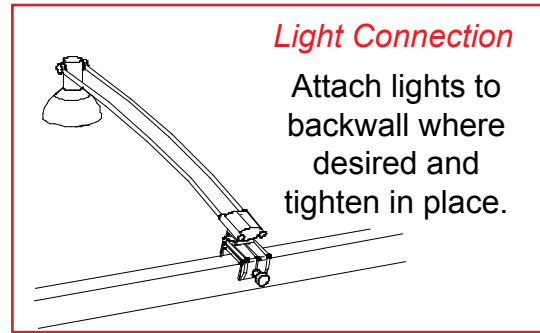

- Steps
- 1) Connect upper and lower vertical extrusions together [13 to 14 and 15 to 16].
  - 2) Connect horizontal extrusions together [17a to 17b and 18a to 18b].
  - 3) Attach horizontal assemblies [17a/17b and 18a/18b] between vertical assemblies [5/6 and 13/14].
  - 4) Attach horizontal extrusions [19 and 20] between vertical assemblies [13/14 and 15/16].
  - 5) Attach support leg extrusions [21] to back of verticals [15], see leg attachment detail.

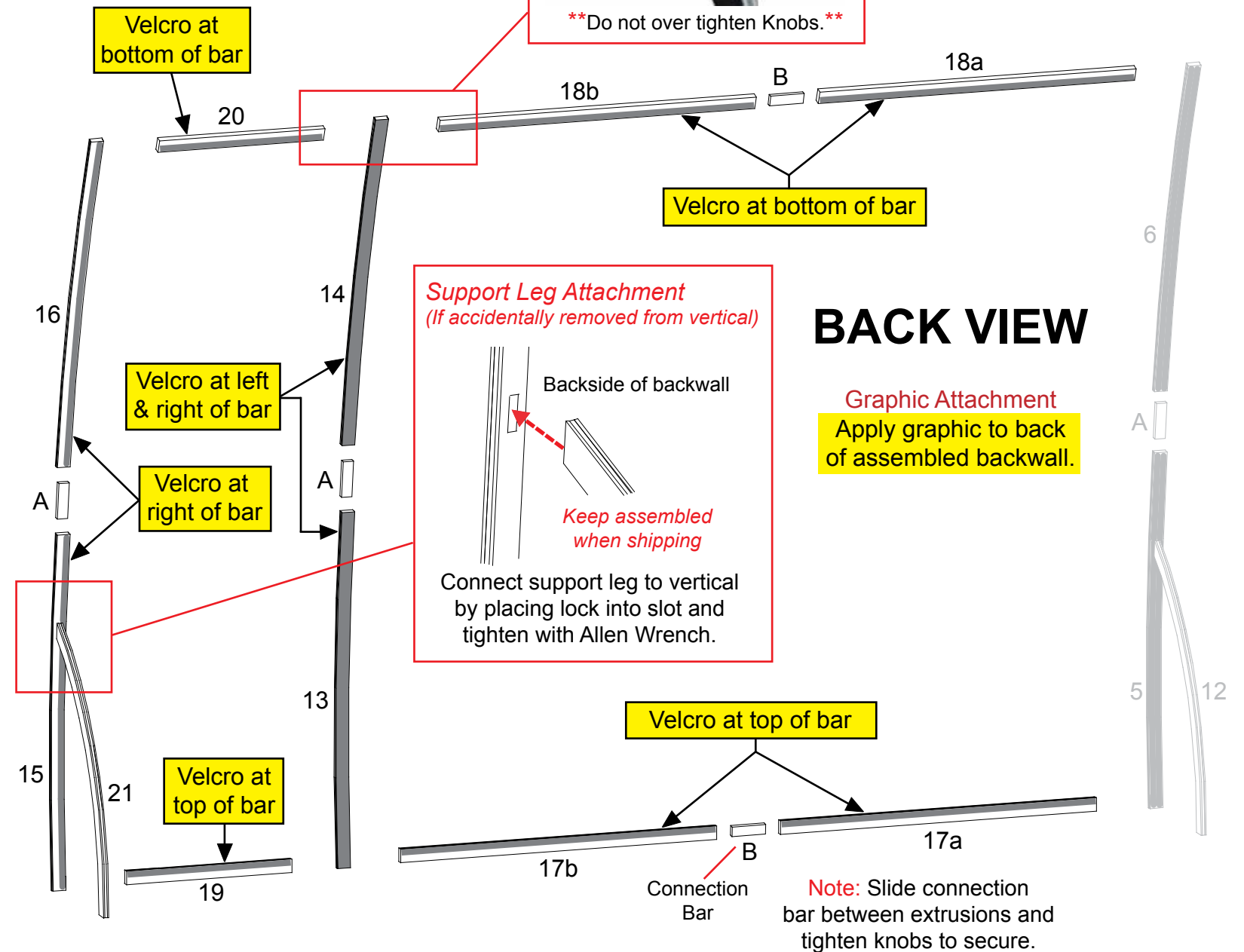
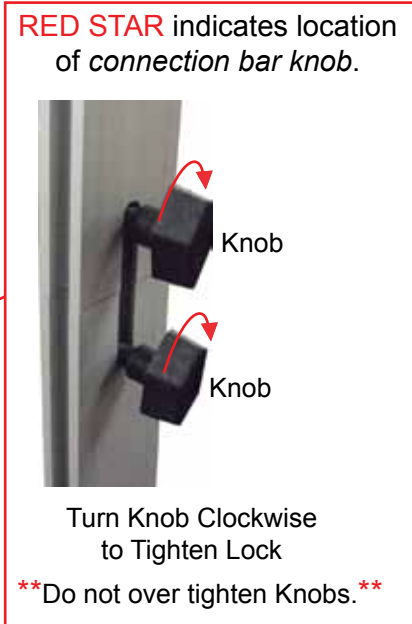
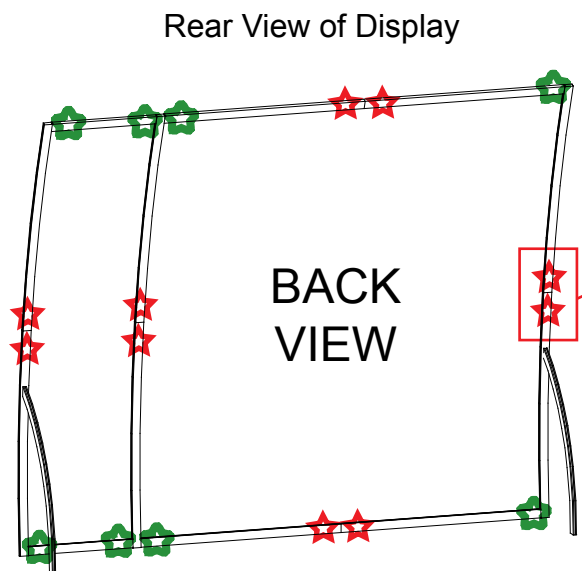

**WHEN DISASSEMBLING ALUMINUM EXTRUSION, TIGHTEN ALL SETSCREWS AND LOCKS TO PREVENT LOSS DURING SHIPPING**

866.652.2100

Part Number	Qty	Description
22	2	Base Plate
23	2	37.6" h Curved Vertical Extrusion
23a	2	Oval Flange Plate
24	2	18.5" w Horizontal Extrusion
25	2	15.69" w Horizontal Extrusion

Steps

- 1) Attach curved vertical [23] to base plate [22], see Base Plate Attachment detail.
- 2) Attach horizontal extrusions [24 and 25] between curved verticals [23] and backwall verticals [3 and 13] where indicated.
- 3) Attach flange plate to top of verticals [23] as shown.
- 4) Place counter tops on assembled counter base, see Counter Attachment detail.

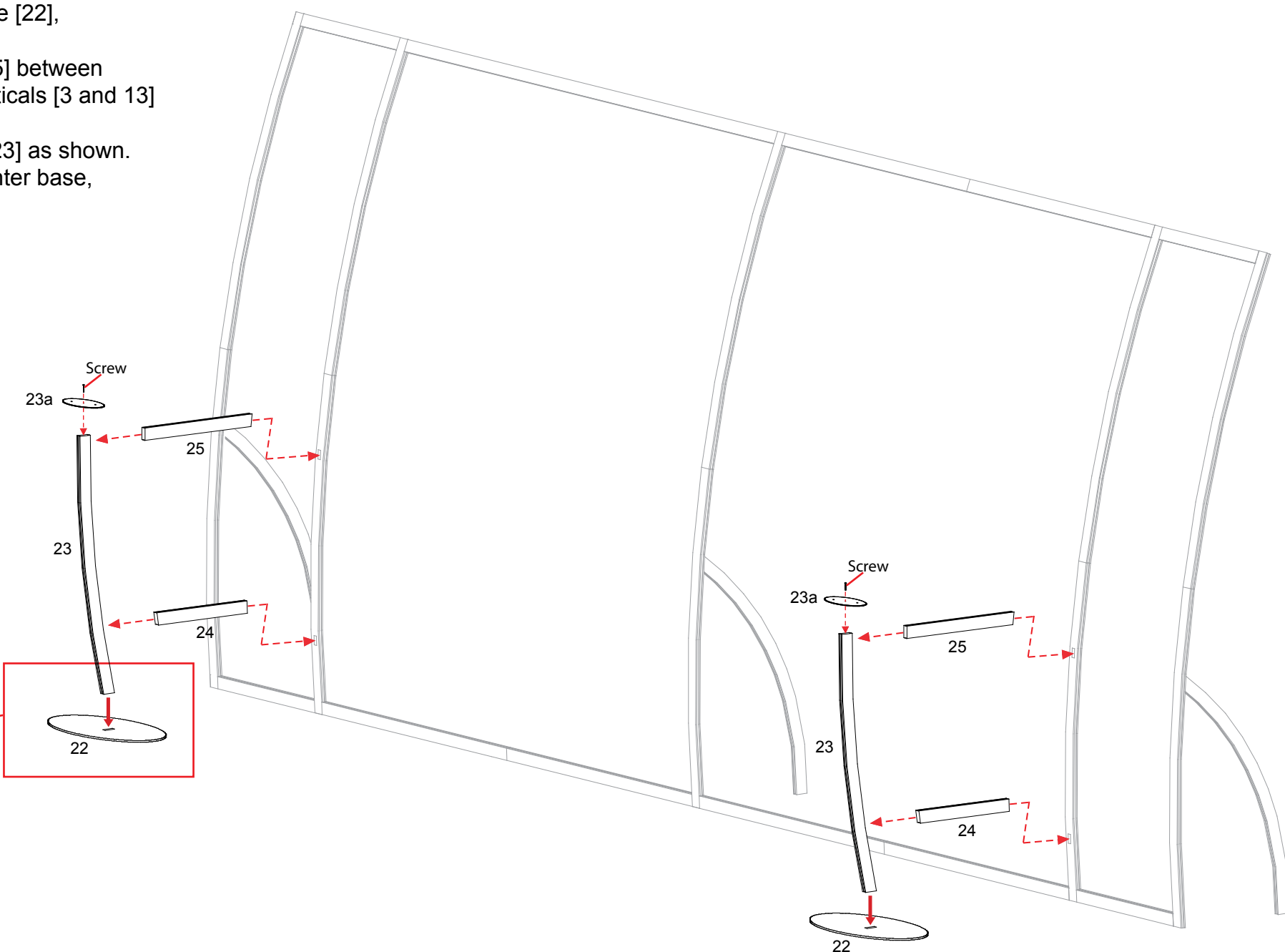

**Base Plate Attachment**

Connect Vertical Extrusion to Base Plate by placing lock into slot and tighten with tool.

**Counter Top Attachment**

Insert screws located on underside of counter into holes on flange plate and secure with wing nuts.

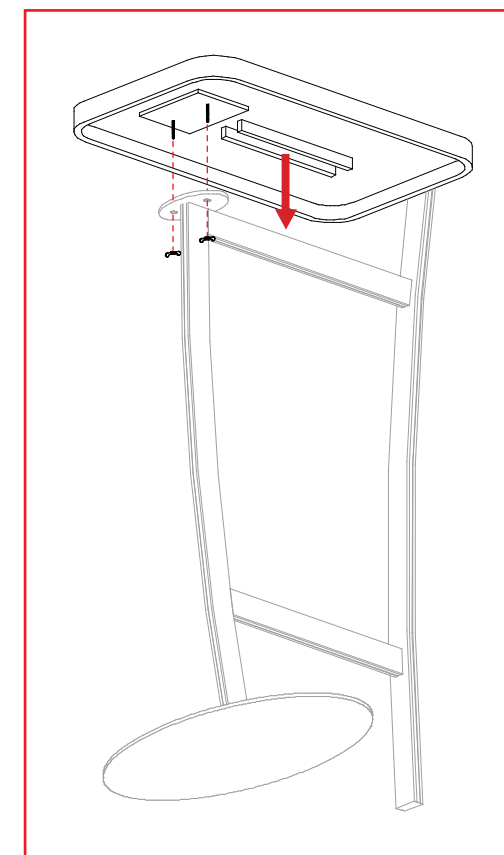

**WHEN DISASSEMBLING ALUMINUM EXTRUSION, TIGHTEN ALL SETSCREWS AND LOCKS TO PREVENT LOSS DURING SHIPPING**

### Top View of Each Level

#### Backwall Components

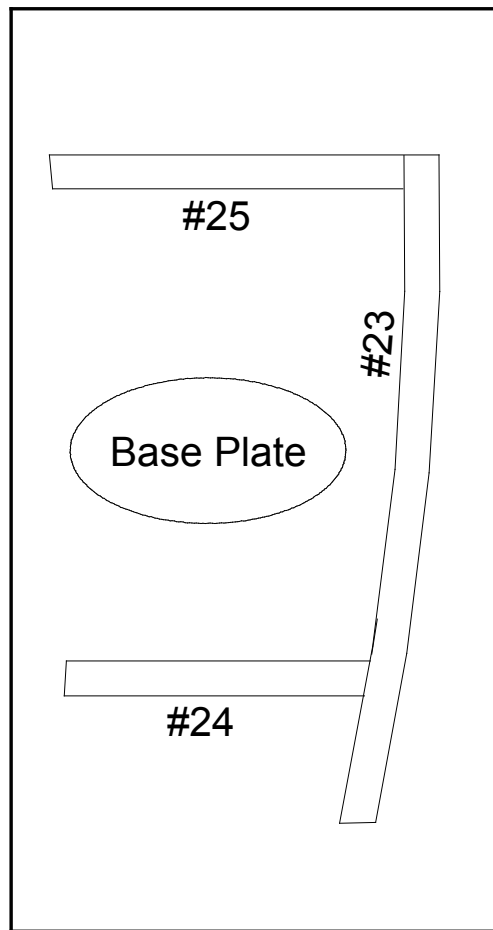

Level 1 (Bottom)

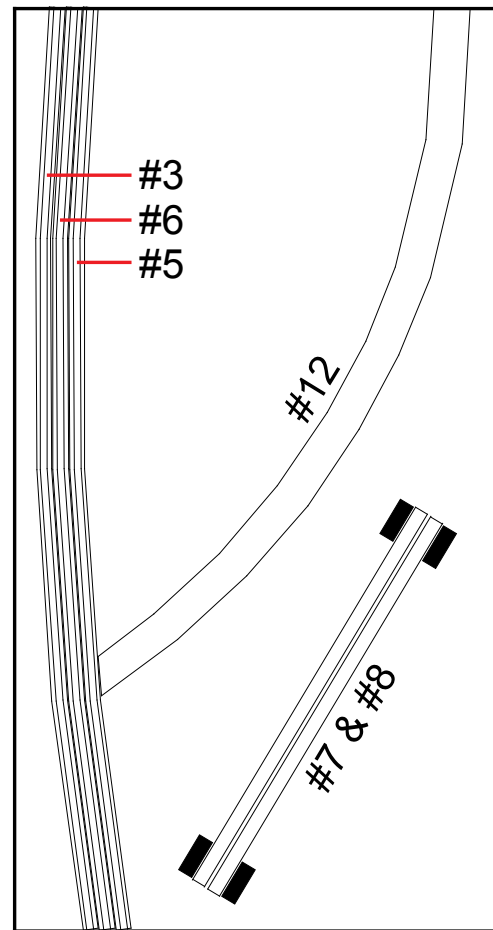

Level 2

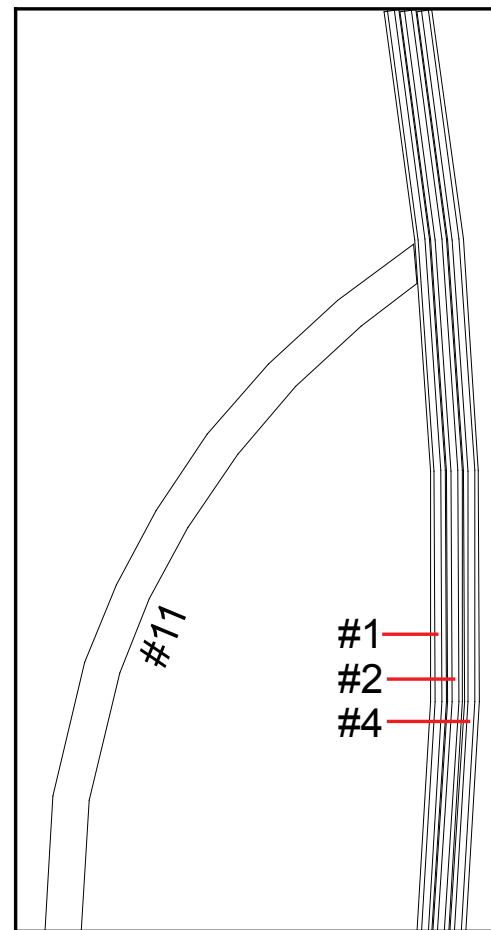

Level 3

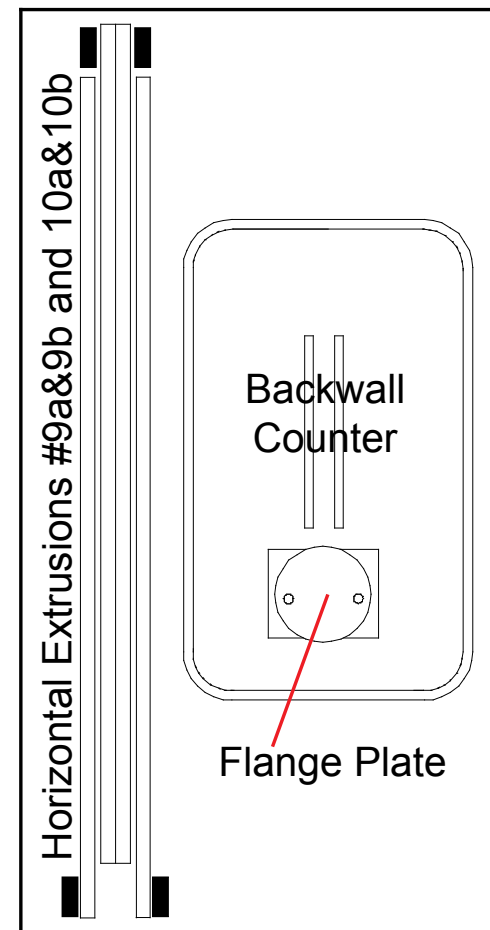

Level 4

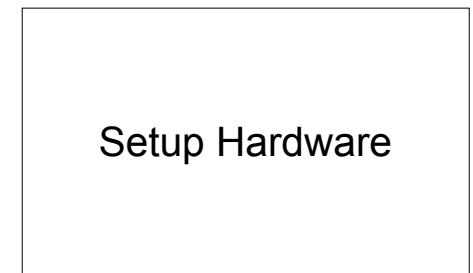
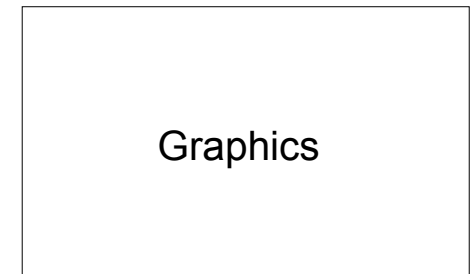
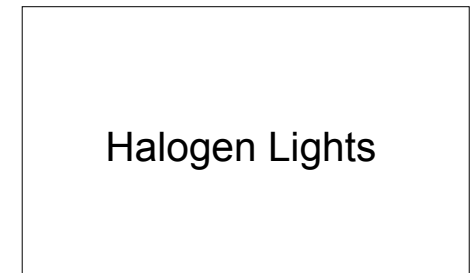

WHEN DISASSEMBLING ALUMINUM EXTRUSION, TIGHTEN ALL SETSCREWS AND LOCKS TO PREVENT LOSS DURING SHIPPING

### Top View of Each Level

#### Backwall Components

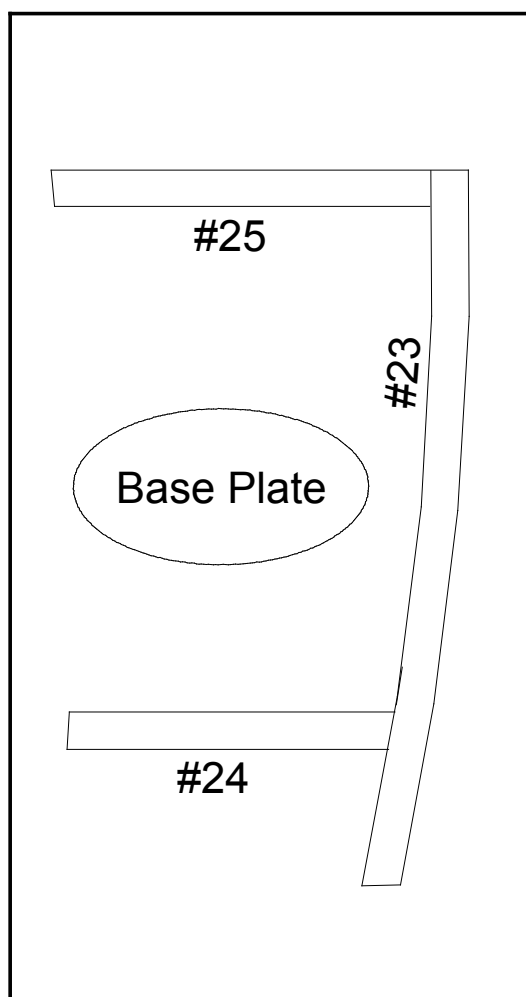

Level 1 (Bottom)

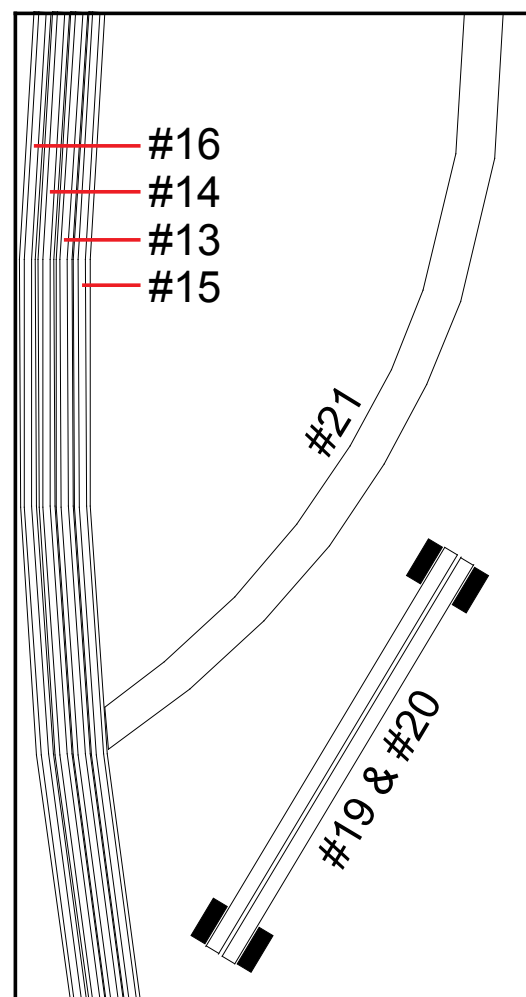

Level 2

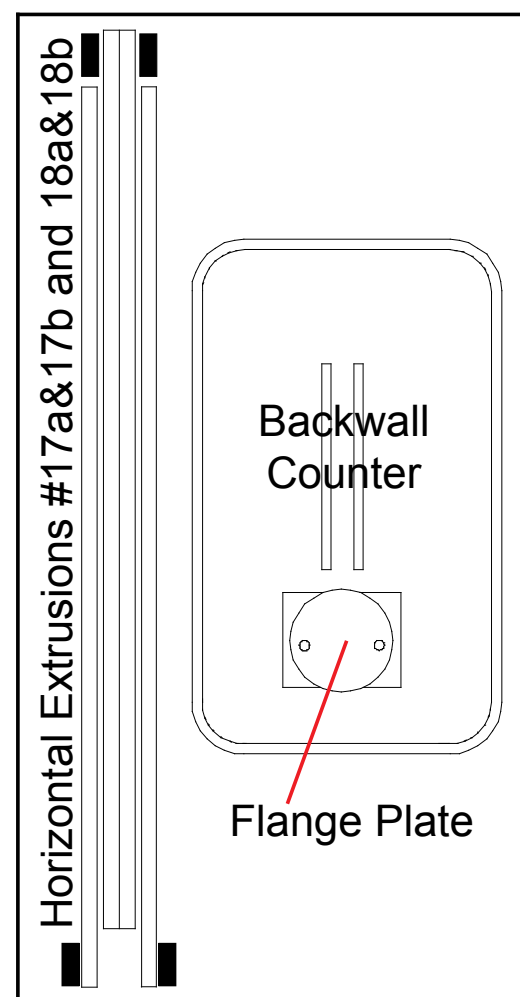

Level 3

Halogen Lights

Graphics

Setup Hardware

**WHEN DISASSEMBLING ALUMINUM EXTRUSION, TIGHTEN ALL SETSCREWS AND LOCKS TO PREVENT LOSS DURING SHIPPING**